

## SUPERIORE

ARTICOLO	TIPO	PESO [KG]	FINITURA
OV4	SX-DX	150	OTTONE
OV4NI	SX-DX	150	NICHELATO
OV4 M	SX-DX	250	OTTONE
OV4 M NI	SX-DX	250	NICHELATO

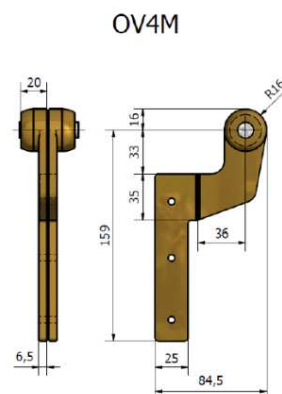
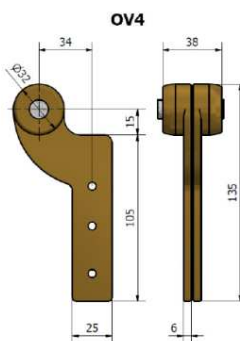

## INFERIORE

ARTICOLO	TIPO	PESO [KG]	FINITURA
OV1	MANO DX PERNO ITALIANO	150	OTTONE
OV1 NI	MANO DX PERNO ITALIANO	150	NICHELATO
OV3	MANO SX PERNO ITALIANO	150	OTTONE
OV3 NI	MANO SX PERNO ITALIANO	150	NICHELATO
OV1M	MANO DX PERNO ITALIANO	250	OTTONE
OV1M NI	MANO DX PERNO ITALIANO	250	NICHELATO
OV3M	MANO SX PERNO ITALIANO	250	OTTONE
OV3M NI	MANO SX PERNO ITALIANO	250	NICHELATO
OV1M RS	MANO DX PERNO TEDESCO	250	OTTONE
OV1M RS NI	MANO DX PERNO TEDESCO	250	NICHELATO
OV3M RS	MANO SX PERNO TEDESCO	250	OTTONE
OV3M RS NI	MANO SX PERNO TEDESCO	250	NICHELATO

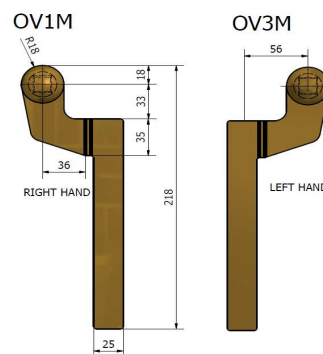
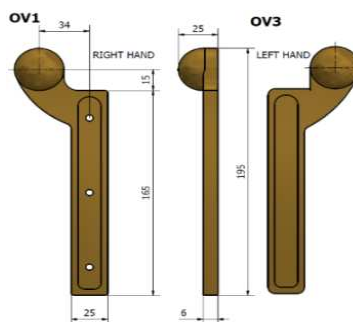

PRODOTTI PROGETTATI  
 E FABBRICATI IN  
 ITALIA

**A. Vavassori**

# Art. AC850

ACCESSORIO PER PORTE CON CERNIERE PORTANTI



GUIDA DI SCORRIMENTO

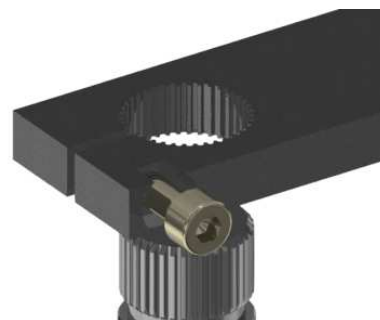
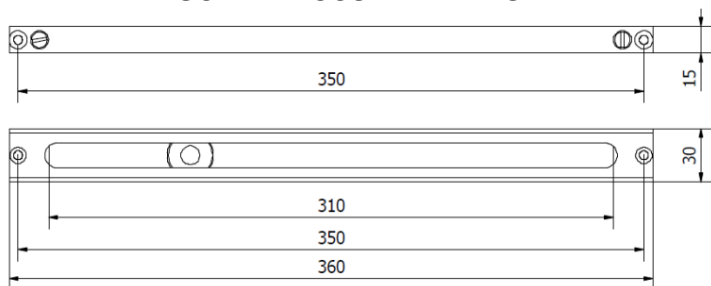

BRACCIO MOBILE

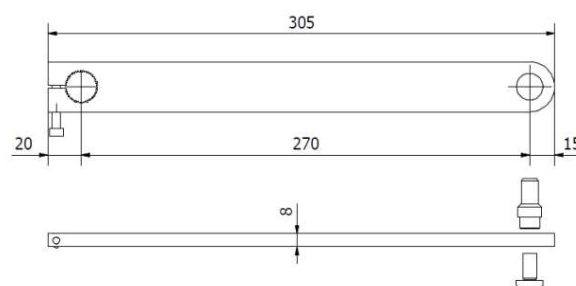

MODULO 1

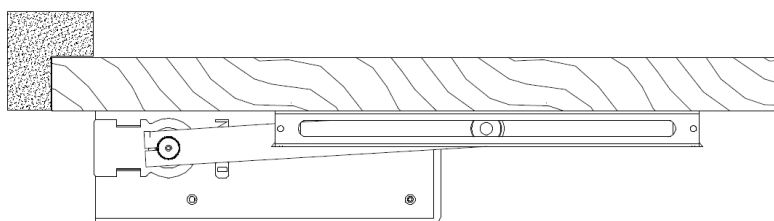

MODULO 2

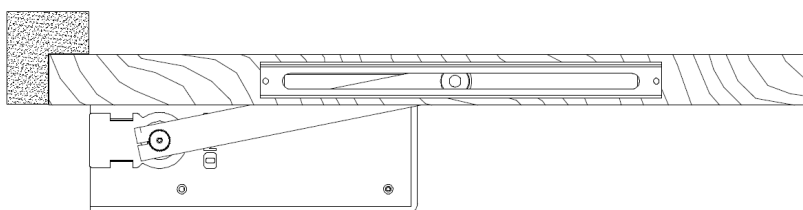

ARTICOLO	TIPO	FINITURA
AC850	SX-DX	NERO ARGENTO